



 Evaporatore progettato appositamente per il condizionamento di grandi locali su veicoli speciali. È corredato di un pannello comandi completo di termostato e selettore a tre velocità di ventilazione, che consentono una perfetta regolazione della climatizzazione. Disponibile anche con riscaldamento (EH 75).

 Évaporateur conçu pour la climatisation de grands compartiments sur véhicules spéciaux. La commande cabine, complète de thermostat et sélecteur à trois vitesses de ventilation, permet une parfaite régulation de la climatisation. Aussi disponible avec chauffage (EH 75).

 Evaporator studied specifically for conditioning big spaces in special vehicles. The control panel, equipped with thermostat and 3 speed selectors, allow a perfect regulation of the air. Also available with heating option (EH 75).

 Verdampfer entwickelt für die Klimatisierung von grosser Räume in Spezialfahrzeuge. Die Steuerung in der Kabine ist mit Thermostat und 3 Gebläsegeschwindigkeiten, die eine perfekte Regulierung der Klimatisierung erlauben. Auch mit Heizung lieferbar (EH 75).

 Evaporador diseñado para acondicionar grandes espacios en vehículos especiales. El panel de control equipado con termostato y tres selecciones de velocidad permite una perfecta regulación del aire. También disponible con la opción de calefactor (EH 75).

EVAPORATORE

E 75

12V cod.20201101 - 24V cod.20201102



EVAPORATORE

EH 75

12V cod.20201103 - 24V cod.20201104

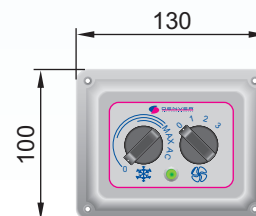
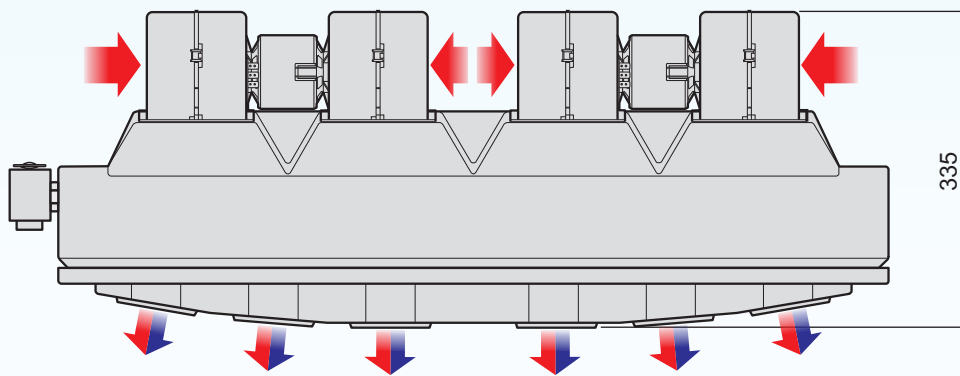
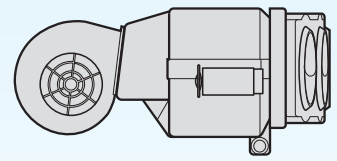
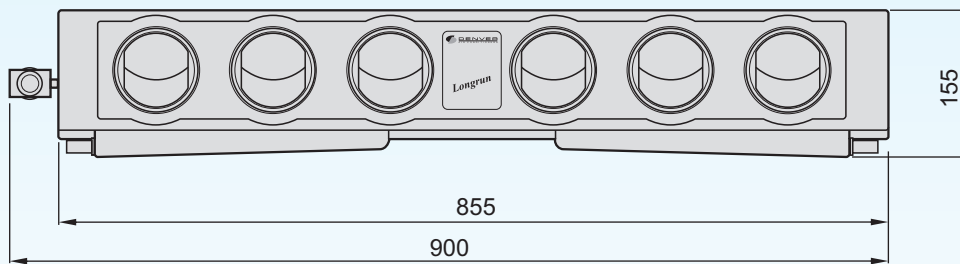

Pannello comandi
Platine commandes
Control panel
Steuerungen
Panel de mando

Dati tecnici nominali	Données techniques nominaux	Nominal technical data	Technische Nominal-Eigenheiten	Datos tecnicos	E 75 - EH 75
• Potenza frigorifera	• Puissance frigorifique	• Cooling capacity	• Kälteleistung	• Potencia frigorífica	7,5 kW
• Potenza riscaldamento	• Puissance chauffage	• Heating capacity	• Heizleistung	• Potencia calefactora	7,5 kW
• Tensione alimentazione	• Tension d'alimentation	• Working voltage	• Spannung	• Tension de alimentacion	12Vc.c / 24Vc.c
• Assorbimento elettrico	• Absorption électrique	• Power consumption	• Stromverbrauch	• Intensidad absorbida	20A (12V) / 10A (24V)
• Portata aria	• Débit air	• Air flow	• Gebläseleistung	• Caudal de aire	850 m ³ /h
• Refrigerante	• Réfrigérant	• Coolant	• Kühlmittel	• Refrigerador	R134a
• Peso	• Poids	• Weight	• Gewicht	• Peso	13 Kg

La nostra società si riserva il diritto di migliorare e modificare ciascuno dei modelli illustrati, senza alcun preavviso.

Notre Société se réserve le droit d'améliorer et de modifier sans aucun préavis chacun des modèles ci-illustrés.

The company reserves the right to modify any design in the model without prior notice as per our policy of continuous improvement of design, quality and performance.

Unsere Firma behält sich das Recht vor, jeden Modell hier erläutert ohne Vorankündigung zu ändern und verbessern.

La compañía se reserva el derecho a modificar cualquier diseño en los modelos sin previo aviso debido a la política de continua mejora en el diseño, en la calidad y en el rendimiento



Autoclima S.p.A. - 10020 Cambiano (TO) - ITALY
Via Cavalieri di Vittorio Veneto, 15 - Tel. 011.94.43.210 - Fax 011.94.43.230
Internet: <http://www.autoclima.com> e-mail: sales@autoclima.com

STAMPATO IN ITALIA - RIPRODUZIONE VIETATA

Cod.80819126